



# JPL Agora BYOD

User Guide

**PROPELLER**  
BY JPL

4K Ultra HD All-In-One Video Sound Bar with Intelligent Zoom



## Unpacking

---

Remove your camera from its packaging and ensure you have the correct specified accessories. Retain the camera box for storage, and also in the unlikely event that it needs to be returned for servicing or repair.

## Warning

---

Ensure that all electrical connections (including extension leads and interconnections between pieces of equipment) are properly made and in accordance with the relevant manufacturer's instructions.

- Do not continue to operate the equipment if you are in any doubt about it working normally, or if it is damaged in any way. If this is the case, disconnect from your PC equipment and consult your dealer.
- Do not allow electrical equipment to be exposed to rain or moisture.
- Never push anything into holes, slots or any other opening on your camera as this could result in a fatal electrical shock.
- Do not open the camera housing as doing so will void the warranty.
- Never guess or take chances with electrical equipment.

## General Limitation of Liability

---

The device is not designed, manufactured, or intended for use or resale, in environments that require fail-safe performance, such as in the operation of life-support systems and/or nuclear facilities. The device may only be used for these purposes with prior written permission from the manufacturer in each individual case.

## Declaration of Conformity

---

This device complies with the basic health, safety and environmental requirements in all relevant directives. You will find the Declaration of Conformity on our website. [www.jpltele.com](http://www.jpltele.com)

## Safety

---

For your own safety, this product should only be used with UKCA, CE, FCC, and RoHS approved equipment. Using this camera with non-approved equipment can void this products warranty.

Unplug this product from the power outlet before cleaning. Do not use liquid cleaners or aerosol cleaners. Use a damp cloth for cleaning.

Do not overload outlets and extension cords as this can result in risk of fire or electric shock.

## Environmental Notice

---

This camera has been made to UKCA, CE, FCC, RoHS, and WEEE standards. In the interest of recycling raw materials, please do not dispose of this camera in the household waste at the end of its useful life. Disposal can take place at approved recycling or disposing locations in accordance with local regulations.

Consult your responsible authority for information about the professional and environment-friendly disposal of your device. If you want that we handle the disposal for you, you can send the device at your costs to JPL Telecom Limited.





## Contents

---

What's Included .....	4
Video Sound Bar - Overview .....	5
Setting up your Video Sound Bar .....	6
Video Enhancement .....	7
External Bluetooth Device Connection .....	7
Technical Information .....	8
- Camera Parameters	
- Microphone Parameters	
- Speaker Parameters	
Technical Information .....	9
- Bluetooth Parameters	
- Other Parameters	
Bluetooth Remote Control .....	10
Bluetooth Remote Control .....	11
Camera Settings - Remote Control - Button Combination .....	12
Re-pairing Settings - Remote Control - Button Combination .....	12
Camera Status Indicator .....	13
Mode Status Indicator .....	13
Trouble Shooting .....	14
Conditions of Warranty .....	15



## What's Included

Thank you for choosing the JPL Agora Bluetooth Conference Room Video Sound Bar.

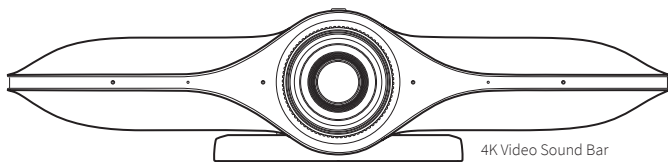

Bluetooth Remote Control  
- Requires 2 x AAA batteries  
(Batteries not included)



Magnetic  
Privacy Cover



USB-A to USB-A or USB-C  
Connection Cable

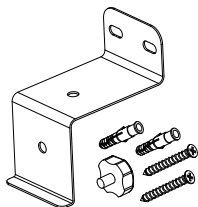

Wall Bracket



Weighted Cable Holder



HDMI Cable

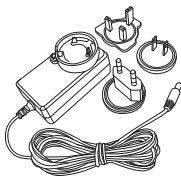

Multi Country DC 12V  
Power Adapter



## Video Sound Bar - Overview

---

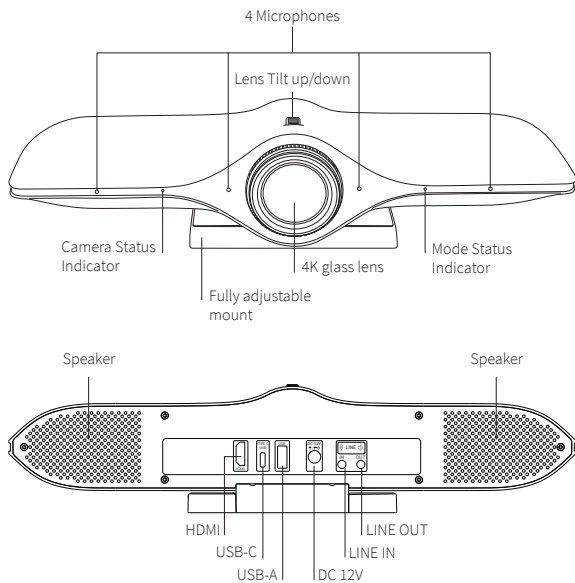



## Setting up your conference room video sound bar

1. Placing your camera - Designed with a fully adjustable mount, the JPL Agora can be placed above a computer monitor, positioned on a desktop, or mounted on a wall or ceiling.

### (a) Monitor Mount

Unfold the adjustable bracket and place the camera on top of your monitor, adjust the angle of the bracket so that it touches the back of the monitor.

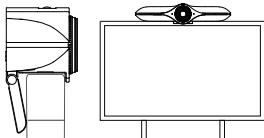

### (b) Wall Mount

Drill holes in the wall that match the pre-drilled holes on the back of the mount.

 Make sure to check you are not drilling into any electrical wires hidden within the wall.

Put rawl plugs into the drilled holes and then attach the mount to the wall using the screws supplied.

Unfold the adjustable bracket.

Align the screw hole sited at the back of the bracket with the screw hole in the wall mount and secure the camera to the wall mount using the hand screw supplied.

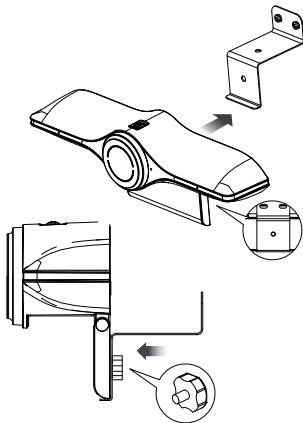



## Setting up your conference room video sound bar

---

2. Connecting your camera is a simple Plug & Play.  
No additional software or downloads are required.
  - (a) Connect the 12V DC jack to the port at the back of the camera and connect the mains adapter to a wall socket.
  - (b) Connect the camera to the display screen using the appropriate cable supplied:
    - (i) USB-A to connect a phone, tablet, keyboard or mouse
    - (ii) USB-C to connect a PC for screen mirroring during in-house meetings or screen sharing during remote video conferencing
    - (iii) HDMI to connect directly to the display screen

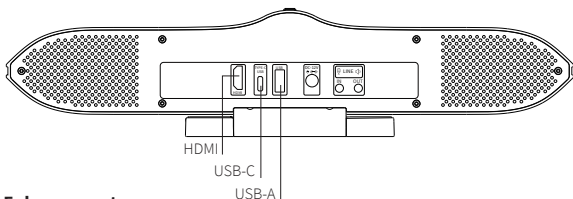

## Video Enhancement

---

To achieve the best camera performance, there are a few things you can do:

1. **Do not** sit in front of a window or other bright light source.
2. Having an uncluttered background will have your viewers concentrating on you rather than looking at what you have in the background.
3. The mounting system allows for tilting and aiming the camera. Tilt and move the camera to frame up everyone around the conference table.
4. Visit your preferred video calling provider's website for exact information on system and requirements.
5. To get a smoother video, especially at high resolution, we recommend network speed above 2Mbps.

## External Bluetooth Device Connection

---

If your PC does not support Bluetooth, then you can use the Bluetooth in the JPL Agora to connect an additional Bluetooth device, such as a speakerphone. Once paired to the PC, you can select to use the speakerphone as your preferred audio device.

To connect an external Bluetooth speaker/microphone, first make sure the external Bluetooth device is in pairing mode and at the same time, plug the JPL Agora camera into the PC.

- Turn on the Bluetooth connectivity on your PC and the device name should appear in the list, click on it to add the external speaker/microphone.



## Technical Information

---

### Camera parameters:

Total Pixels	8.3 million pixels - 4K
Focus Mode	Fixed Focus
Aperture	F/No. =2.5 ±5%
Image Colour	24 Bit
Maximum Effective Pixel	3840 x 2160 @30fps
Output Image Format	H.264 (MPEG-4/AVC)
Picture Adjustment	Brightness, Chroma, Saturation, Contrast, Sharpness
Field of view	D=116° H=107° V=74°
Pan	0°
Tilt	±15°
Intelligent Zoom	16 step, 3 x digital zoom
Minimum Illumination	0.5 Lux
Exposure	Automatic Exposure (AE)
AIC	Auto White Balance (AWB), Dynamic Black Level, Calibration (ABLC)
Resolution @ 30fps	3840 x 2160, 1920 x 1080, 1280 x 720, 640 x 480

### Microphone parameters:

MIC Specification	4 x digital microphones
SNR	≥65.5dB
Sensitivity	-26dB Fs
Far-field voice pick-up	0-10 metres
Horizontal voice pickup	Horizontal 180°
Communication mode	Full duplex

### Speaker parameters:

Speaker Specification	2 x ø40mm x H 28mm
Power	3W each
Impedance	4Ω
Frequency Range	20Hz~20KHz
Distortion	5% Max





## Technical Information

---

### Bluetooth parameters:

Bluetooth Standard	Bluetooth 4.1/EDR/BLE
Frequency	2400 ~ 2480MHz
TX Power	4±1.5dBm (typical)
RX Sensitivity	-85dBm (typical) $\pi/4$ DQPSK
Operating Systems	Windows; Linux; Android
Operating Distance	10 metres

### Other parameters:

Interface type	USB 3.0 Type-A or USB Type-C, Line In, Line Out, Bluetooth
Voltage	DC 12V < 2000mA
OS Support	Win 2000/XP/Vista/Win 7/Win 8/Win 10, Win CE with UVC, Linux with UVC (above Linux - 2.6.26), Mac OS X 10.4.8 or later, Android 4.0 with UVC
Size	L352 x W75 x H80mm
Weight	960g



## Bluetooth Remote Control

---

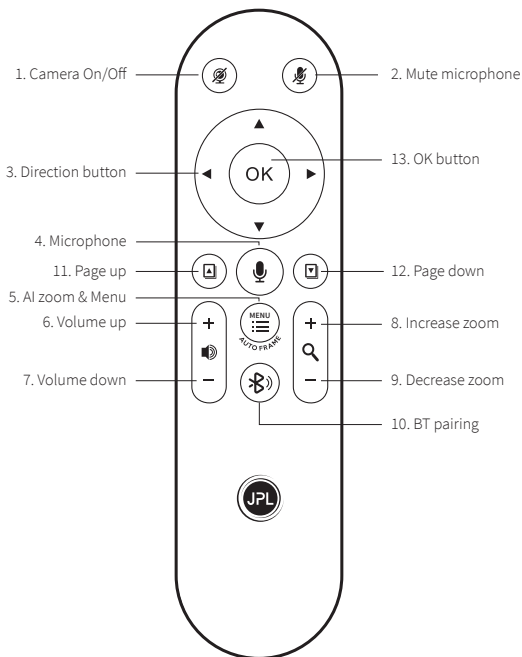



## Bluetooth Remote Control

---

Function	Operation
1. Camera On/Off [  ]	Single press to turn the video picture on/off
2. Mute Microphone [  ]	Single press to mute / unmute camera microphone
3. Direction button	Control direction movement of video picture - (AI Zoom must be turned off) [  ] Move up, [  ] Move down, [  ] Move left, [  ] Move right
4. Microphone [  ]	Long press without release to switch to built-in microphone of remote controller, release to switch to camera microphone
5. AI zoom & Menu [  ]	Single press to turn AI zoom on / AI zoom off
6. Volume up [  ]	Single long press to increase volume (Synchronise volume control with PC )
7. Volume down [  ]	Single long press to decrease volume (Synchronise volume control with PC )
8. Increase zoom [  ]	Single long press to increase the zoom - (AI Zoom must be turned off)
9. Decrease zoom [  ]	Single long press to decrease the zoom - (AI Zoom must be turned off)
10. BT Pairing [  ]	Single click to pair the remote control to the Agora camera
11. Page up [  ]	For scrolling to next page when viewing multi-page documents
12. Page down [  ]	For scrolling to previous page when viewing multi-page documents
13. OK button [  ]	Long press (5s) [  ] button to confirm or reset to standard settings



## Camera Settings - Remote Control - Button Combination (Step-by-Step)

Function	Operation
Activate Settings Mode	Long press (5) <b>AI zoom &amp; Menu</b> [  ] for 5s and release then press any button to set video picture effect. Press (13) [ OK ] to confirm and exit.

## Adjustable Camera Settings - Remote Control - Button Combination (Step-by-Step)

Function	Operation
Camera Brightness	Press (6) <b>Volume up</b> [  ] / (7) <b>Volume down</b> [  ]
Camera Contrast	Press (8) <b>Increase zoom</b> [  ] / (9) <b>Decrease zoom</b> [  ]
Camera Colour Saturation	Press (11) <b>Page up</b> [  ] / (12) <b>Page down</b> [  ]
Screen Mirror Effect	Press (3) <b>Direction button</b> [  ] Move up, [  ] Move down to mirror the screen horizontally [  ] Move left, [  ] Move right to mirror the screen vertically
Move the Image after Magnification	Press (12) <b>Page down</b> [  ] and then press (3) <b>Direction button</b> [  ] [  ] [  ] [  ] to move the image accordingly

## Re-pairing Settings - Remote Control - Button Combination

Function	Operation
Clear Bluetooth settings	Long press (3s), (13) [ OK ] and (11) <b>Page up</b> [  ] together
Enter Pair Bluetooth mode	Long press (3s), (10) <b>BT pairing</b> [  ]

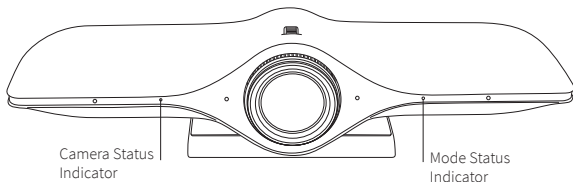

## Camera Status Indicator

Visual Indicator	Operation
Blue light stays on/turns off	Camera opened/closed

## Mode Status Indicator

Visual Indicator	Operation
Light flashes or stays on	Camera has Power and is Active
Blue light flashes	Camera & Remote Control Unpaired
Blue light stays on	Camera & Remote Control Paired
Red light stays on/turns off	Microphone mute turned on/off
Purple light stays on	External microphone connected
Red and blue lights flash alternately	Long press (5) <b>AI zoom &amp; Menu</b> [  ] on the remote control to enter into setting mode, press (13) [ <b>OK</b> ] and the flashing light will disappear
Purple light flashes 3 times	Long press (13) [ <b>OK</b> ] for 3s to 5s to enter RESET





## Trouble Shooting

---

### **1) No reaction when using the Bluetooth remote controller**

- a) If you do not see a red LED light when pressing any button on the remote controller, check to see if the remote controller has batteries and that they are installed correctly.
- b) Repower the JPL Agora Camera and then press **BT pairing** [  ] for 3s. If this does not work, hold both **OK button** [  ] and **Page up** [  ] buttons down for 5s to reset Bluetooth settings. Now try again.

### **2) Blue LED light flashes slowly on camera**

- a) Turn off the power for 3s and then reconnect it.
- b) Press **OK button** [  ] and **Page up** [  ] buttons at the same time for 3s until red LED on remote controller turns off.
- c) Press **BT pairing** [  ] for 3s.

### **3) Image displays abnormally**

- a) Check that the lens is clean.
- b) Press **OK button** [  ] for 3-5s to enter RESET.

### **4) Microphone is not active**

- a) Check to see if the JPL Agora is set as the default camera in the microphone settings on your PC.
- b) Check if the microphone has been muted by the remote controller.

### **5) PC fails to read this camera**

Check all cables are correctly connected.

### **6) No image displayed / The image breaks frequently**

Check all cables are correctly connected.

### **7) The video quality is not good after accessing software**

Check your video quality settings on the PC.



## Conditions of Warranty

---

1. JPL Telecom Limited, Head Office: Units 1 & 2, Church Close Business Park, Church Close, Todber, Sturminster Newton, Dorset DT10 1JH, England, grants 3 year limited manufacturer's warranty\* from the date of purchase, as the manufacturer of this product.
2. For you, as a consumer, this means: We guarantee that our devices are error-free when supplied. If a manufacturing error is identified within 36 months\* of the delivery date we will repair or replace the device free of charge without you, as the consumer, having to provide the usual legally required proof that this fault was present when you received the device. We either use new parts or parts in mint condition for the repair or replacement delivery. Any parts removed from the device become our property and can be destroyed by us.
3. In addition to this warranty, you have the unlimited legal right to claim against the supplier on the basis of the terms of the warranty for defects on the basis of the purchase contract. However, in contrast to our Manufacturer's Warranty, the legal warranty for defects only applies to the device's state when sold.
4. You can only claim against this warranty if you return the faulty device to JPL Telecom Limited or our local general importer or distributor, outside England, at your own cost, with a valid proof of purchase (invoice or till receipt). When you return it to us, please provide a detailed description of the fault that has occurred, and also tell us your telephone number, in case we need to contact you. To prevent shipping damage, provide suitable transport packaging (e.g. original packaging with a secondary shipping box).
5. The Manufacturer's Warranty excludes damage caused by mishandling, operating errors, misuse, external influences, lightning strikes/power surges, modifications to the product and extensions. Shipping damage, consequential damage, and costs arising from down times and travel times are also excluded.
6. Do not open the camera housing as doing so will void the warranty. The warranty is cancelled if repairs are carried out by unauthorised agents.

\*3 years limited warranty (2 years standard repair or replacement warranty plus a 3rd year cover on the camera only)



## REGISTERED ADDRESS

---

### **UK Office: JPL Telecom Limited**

Units 1 & 2, Church Close Business Park, Church Close, Todber, Sturminster Newton, Dorset, DT10 1JH, England

### **USA Office: JPL Telecom Holdings LLC**

445 W Merritt Ave, Merritt Island, FL 32953, USA

### **EMEA Office: JPL Telecom B.V.**

John M. Keynesplein 10, 1066EP Amsterdam, Netherlands

---

Registered in England No. 5250754

[www.jpltele.com](http://www.jpltele.com)

E&OE 03/24

